



workshop



custodia in cartone per il multimedia
michele monopoli

ONE WAY
obiettivi di progetto

Eliminare il tray in polistirene per l'alloggiamento del DVD all'interno della custodia in cartone, per favorire l'omogenità di materiale.



Cercare di trasferire al cartoncino un significato Hi-Tech per il multimedia.

ONE WAY
schizzi e modelli di studio

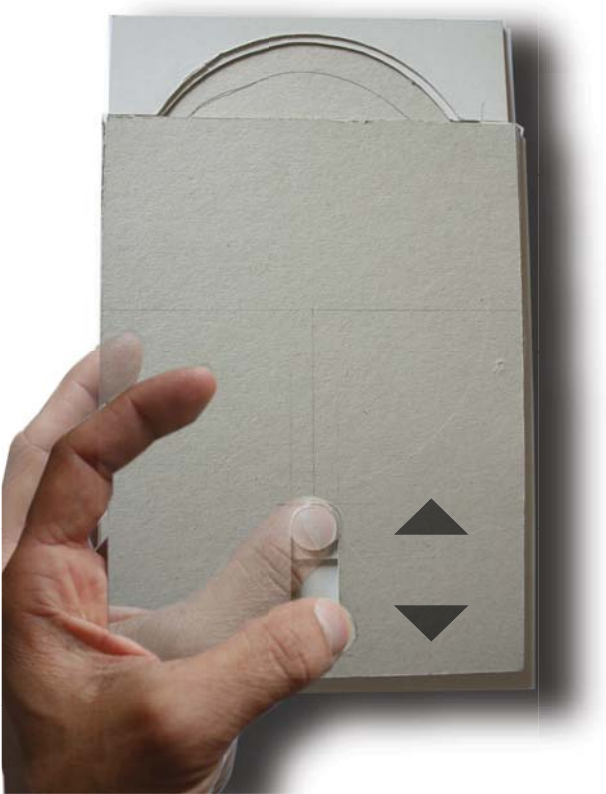
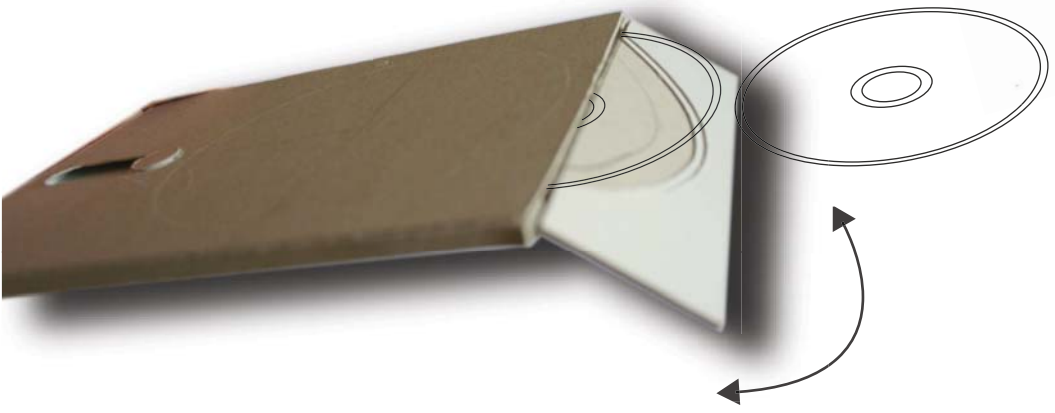
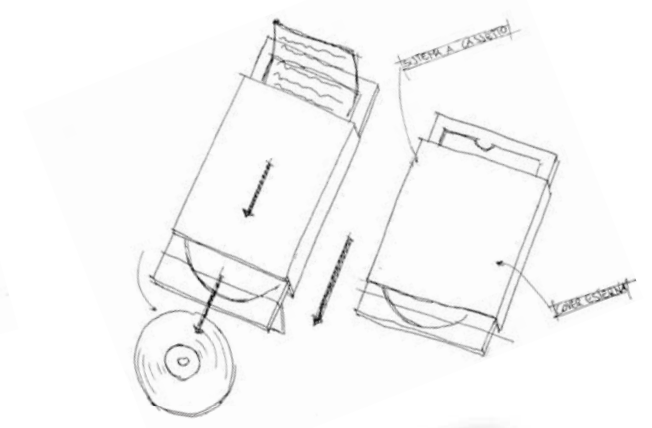
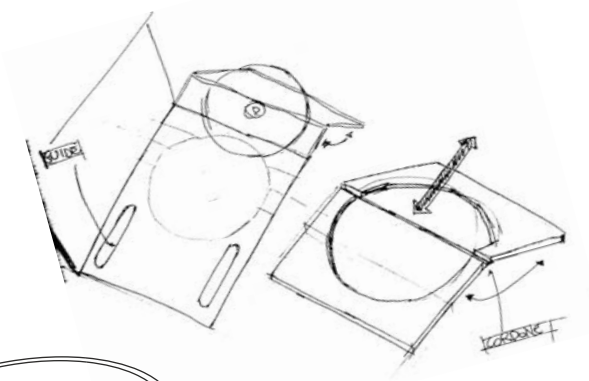

ONE WAY
schizzi e modelli di studio

step 1



step 2



step 3

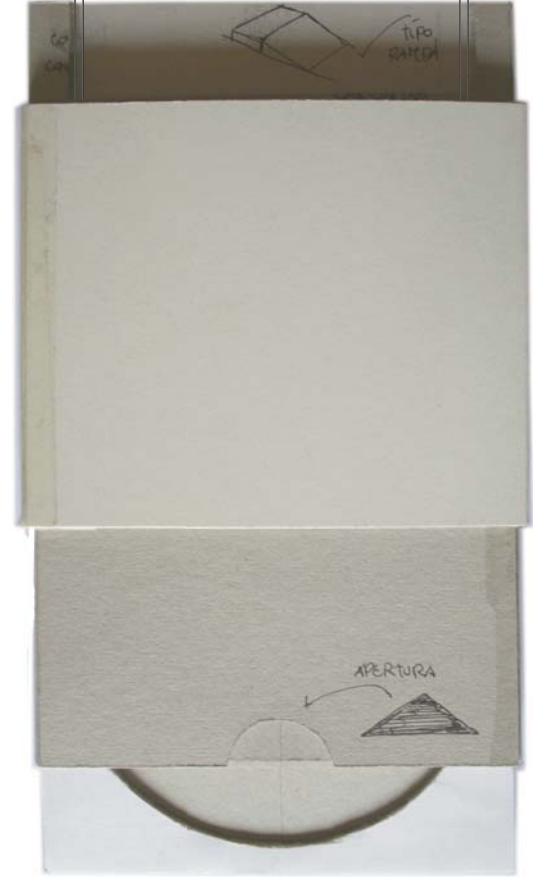



step 1

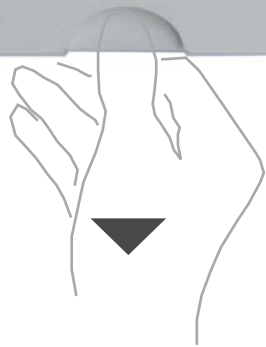

Il prototipo finale permette l'accesso ai diversi contenitori con una sola azione di scorrimento.

step 2

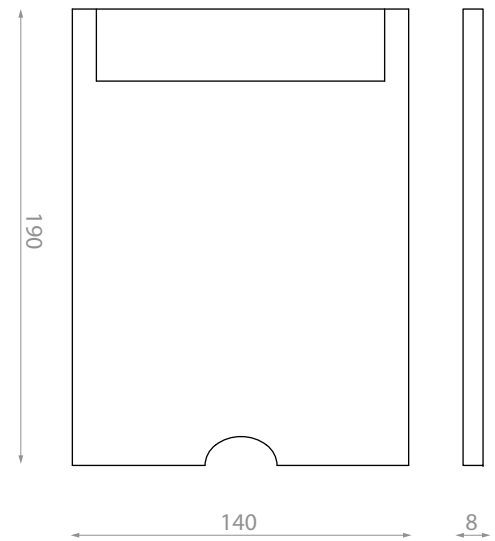
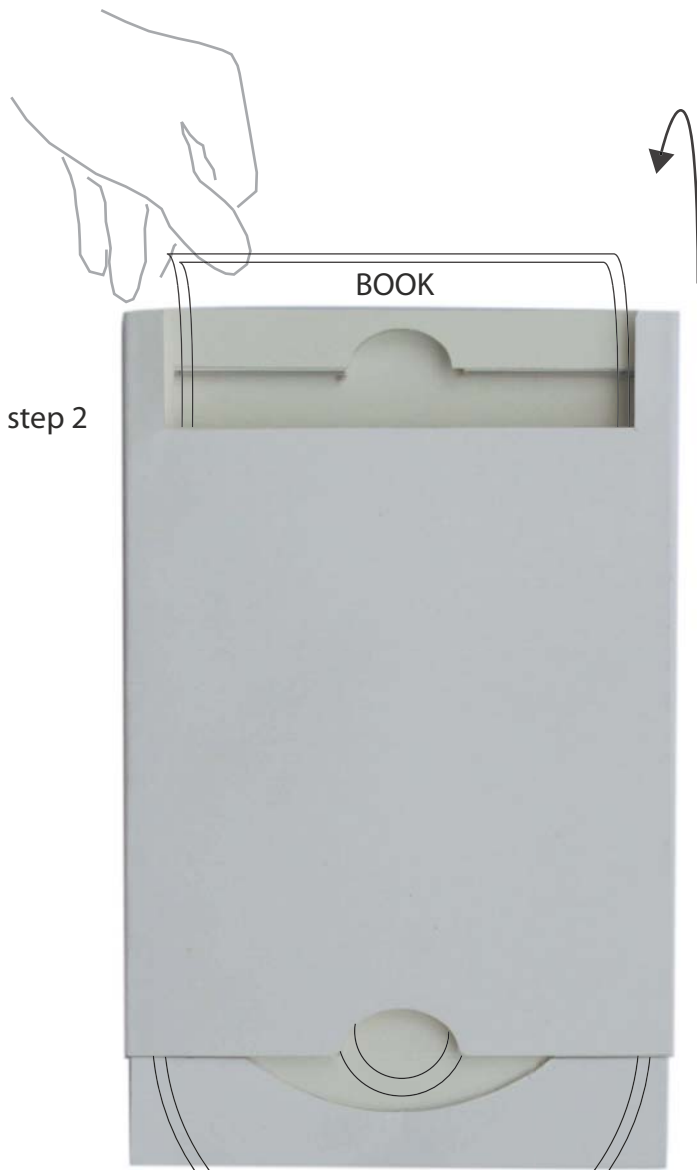



Il prototipo è stato realizzato con cartoncino NOVA X 370 g, mentre la fustella per il libretto è in cartone rigido da 3 mm (spessore libretto)

fustella libretto

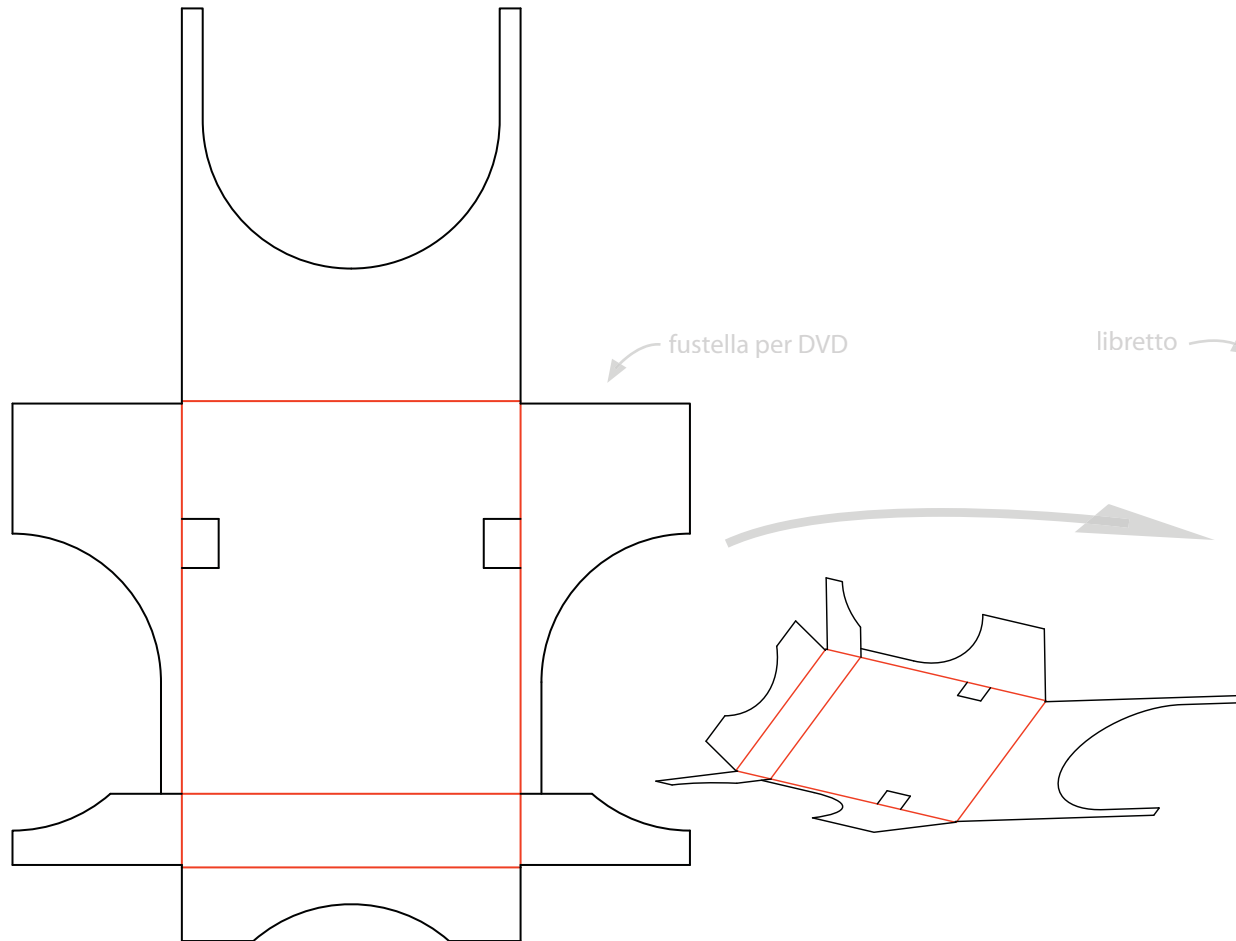
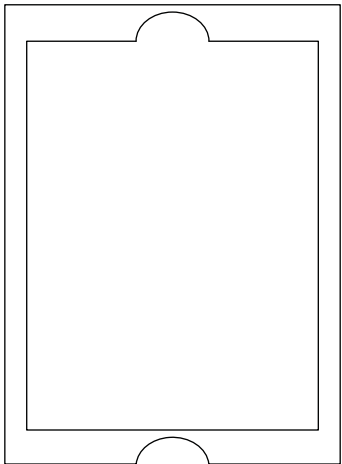

fustella per DVD

libretto

fustella per cover

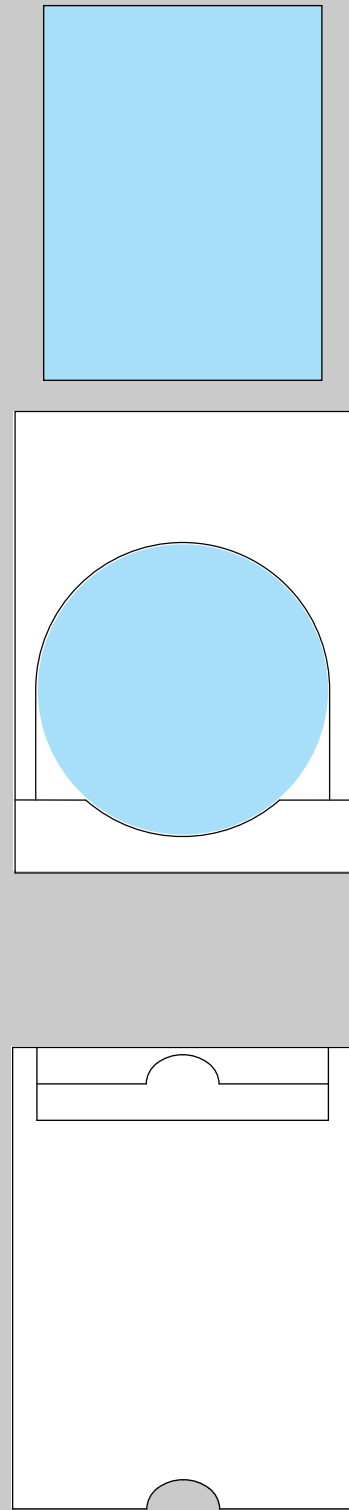
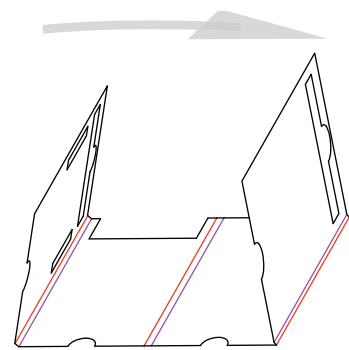
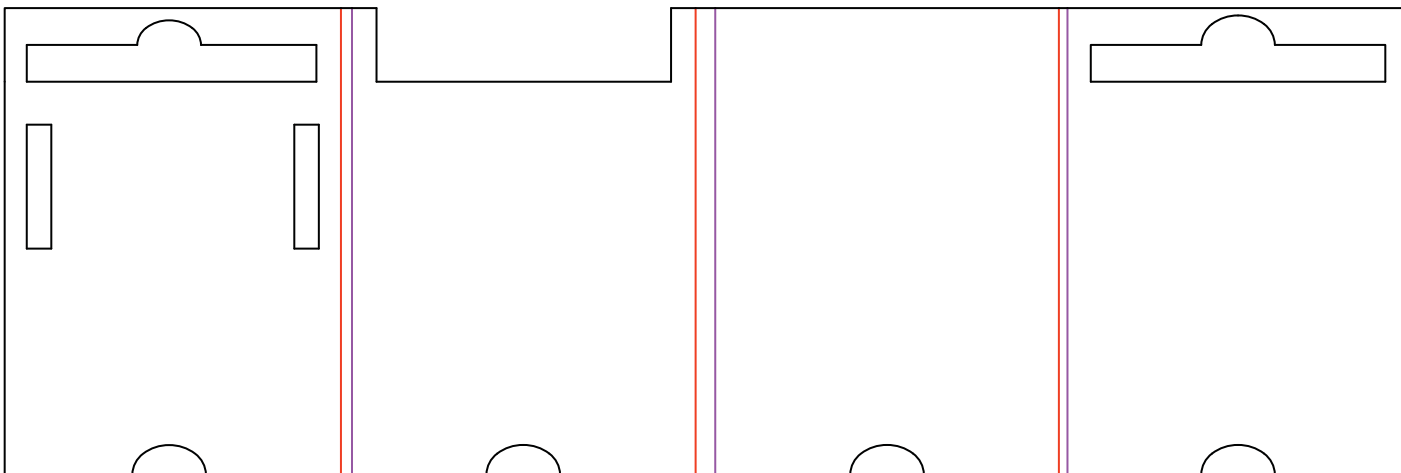

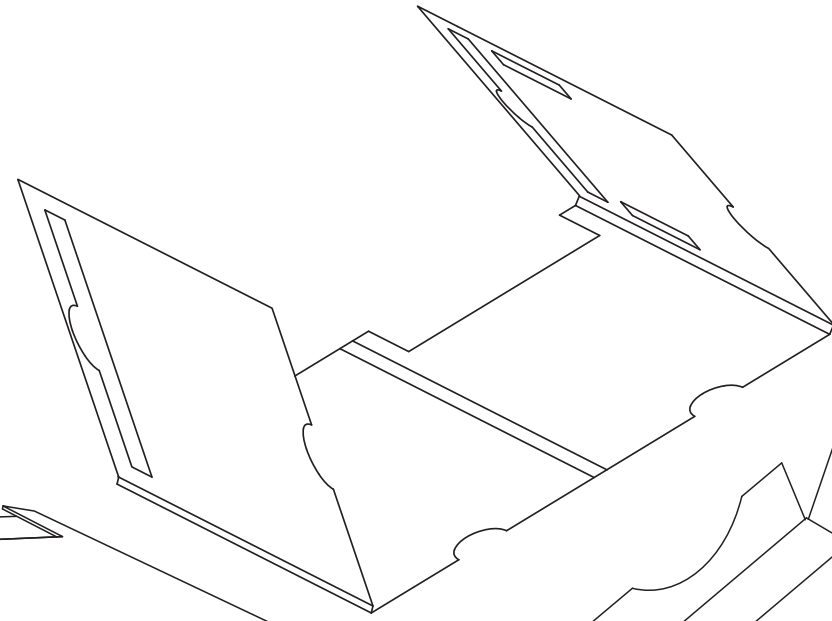
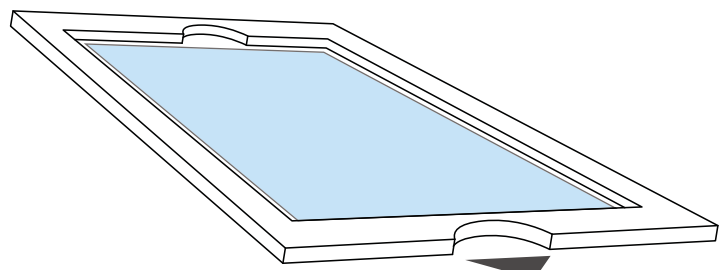

Piegatura ed incollaggio delle fustelle.

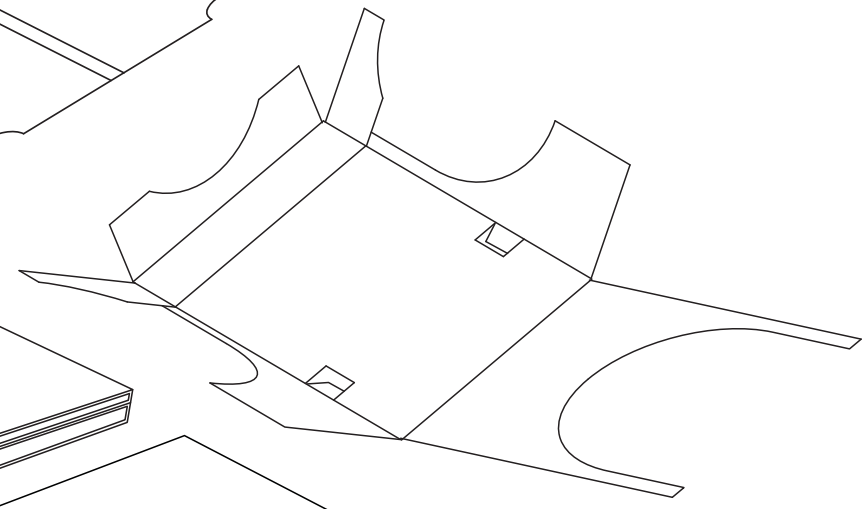

Dopo la fase di piegatura della cover centrale vengono inseriti nei due alloggi i contenitori per il multimedia.

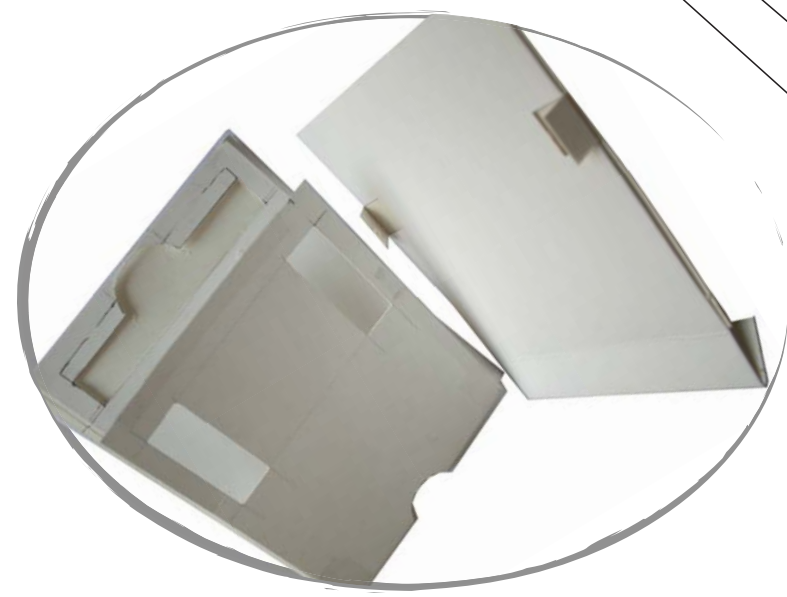
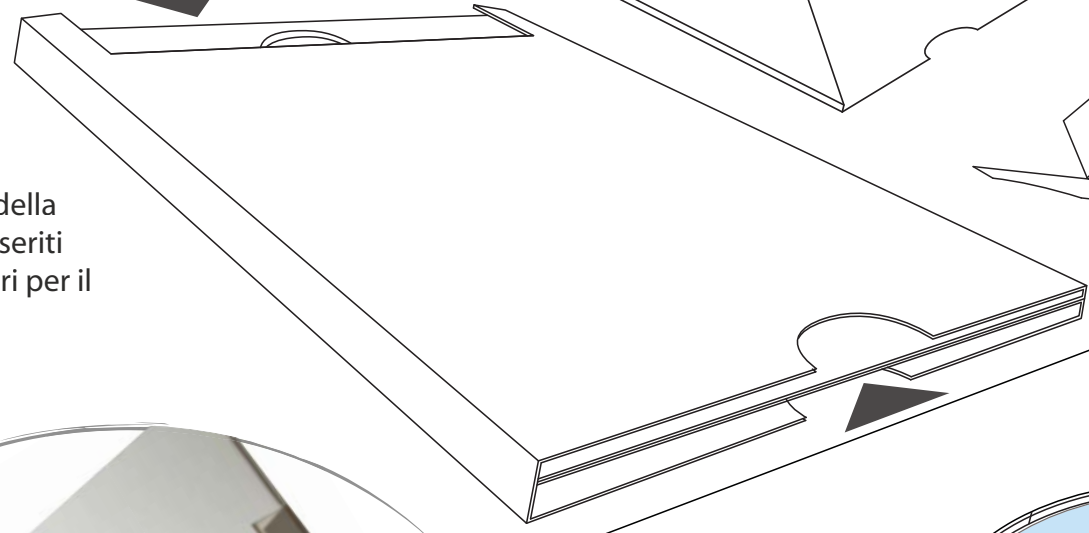

Particolare del sistema di scorrimento del contenitore.

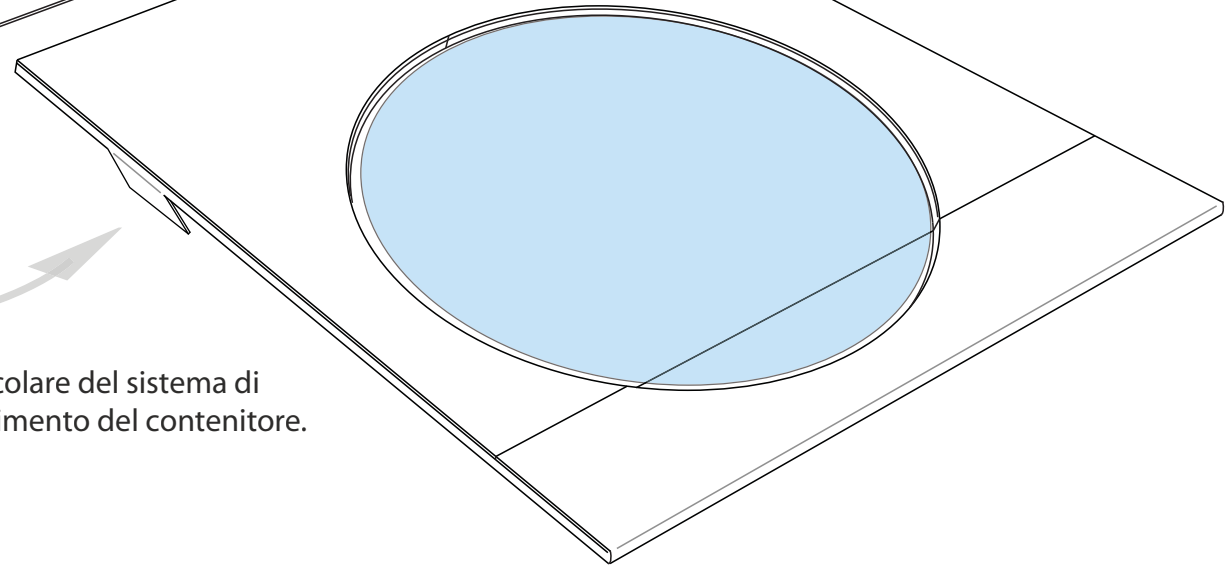



ONE WAY è stato impiegato per la realizzazione di custodie per film in blue ray per il brand Warner Bros.



left

front

right

back

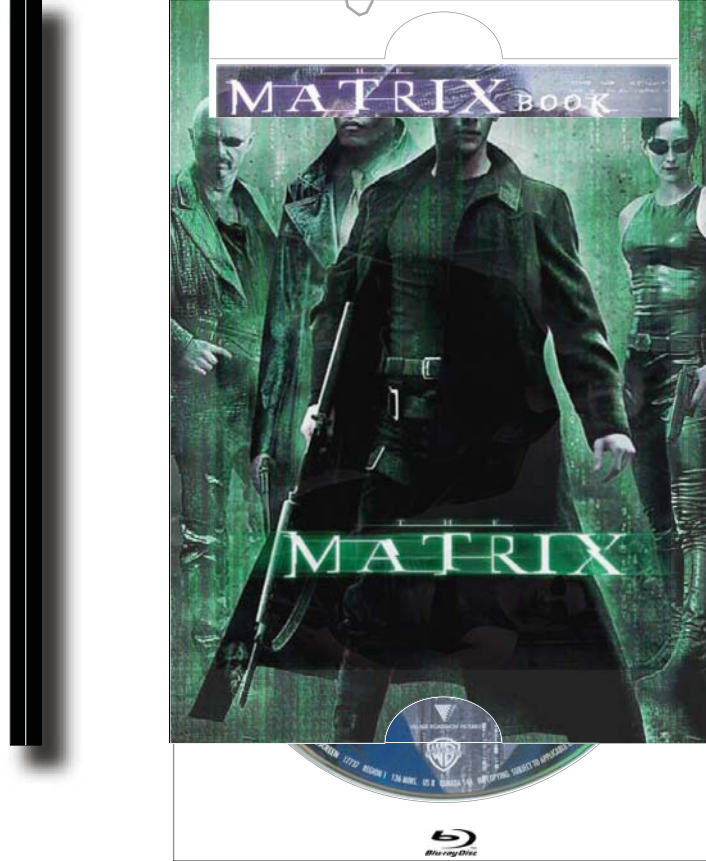
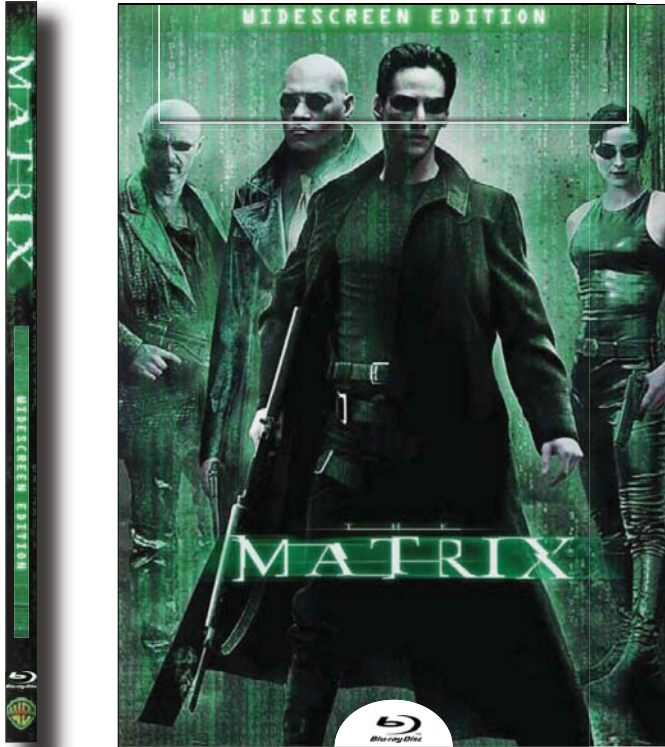

La grafica a tutta superficie rappresenta un adattamento ai sistemi tradizionali di illustrazione.





Le immagini su cartoncino sono state stampate mediante processo litografico.

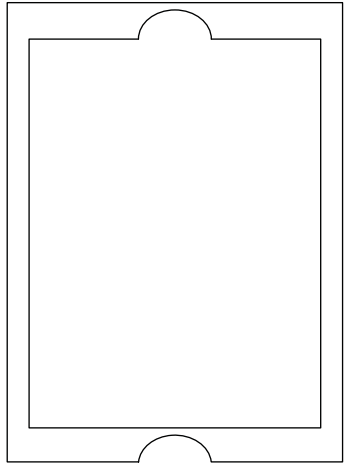
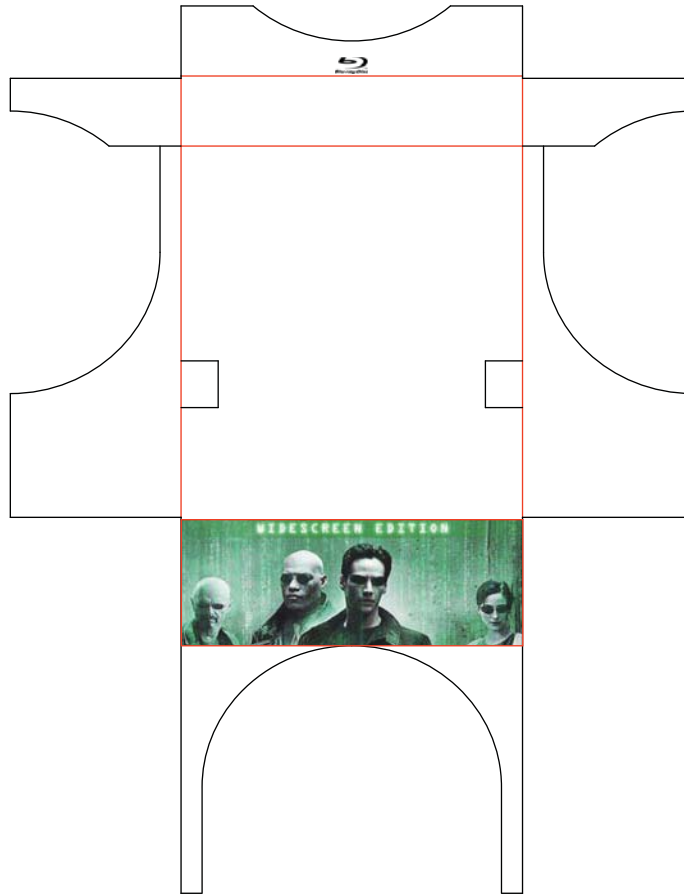

Applicazione della stampa al prototipo.

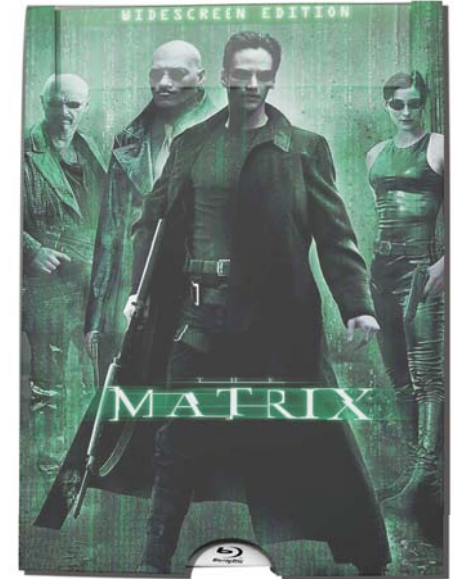



ONE WAY è stato impiegato per la realizzazione di custodie per una raccolta di film in blue ray per il brand Warner Bros.

left

front

right

back

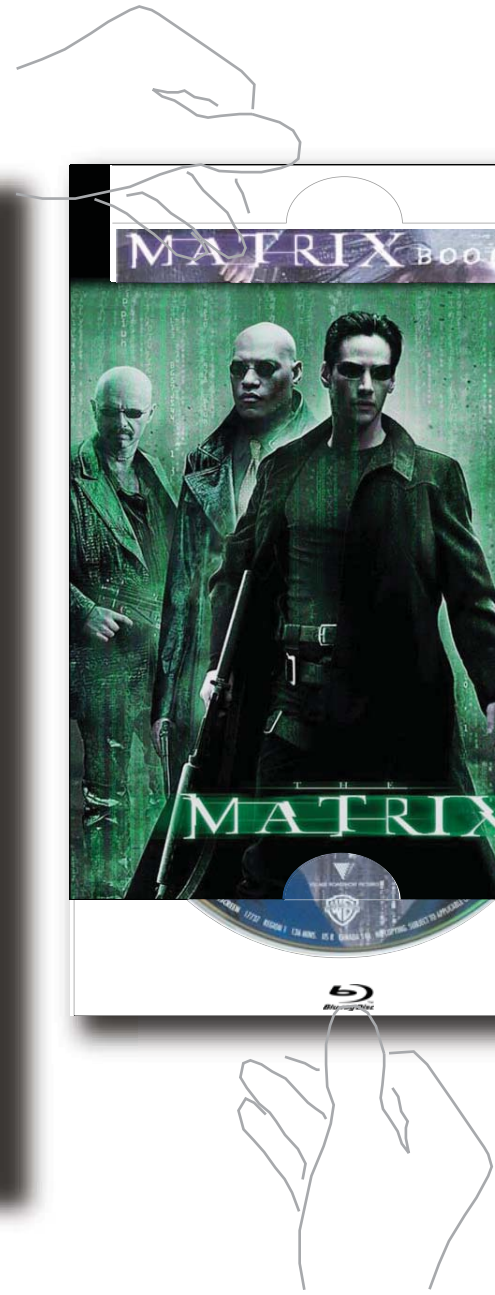
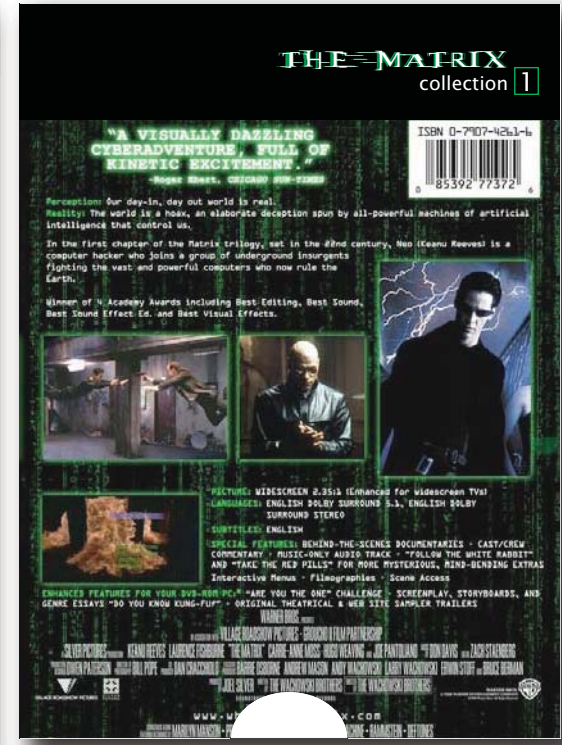
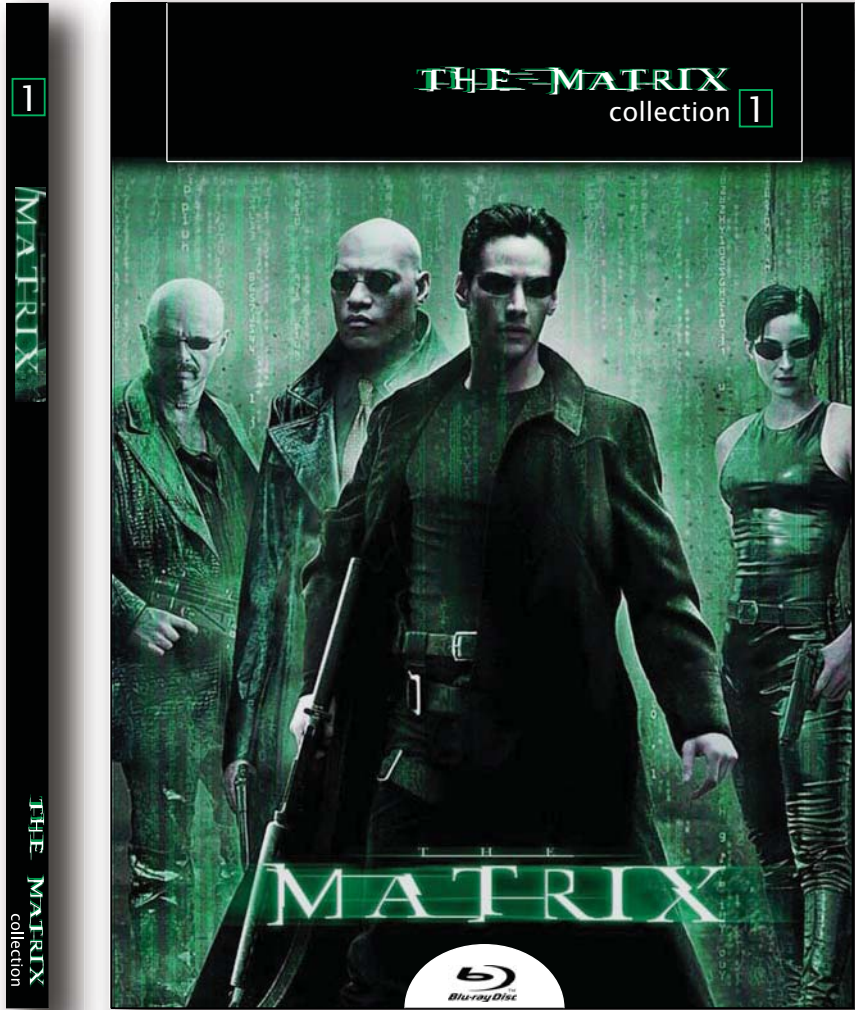



ONE WAY è stato impiegato per la realizzazione di custodie per una raccolta di film in blue ray per il brand Warner Bros.

